

TOK

Da
From - A partir de
139€
di listino



GROWING BEAUTY

LOMBARDO



made in Italy

50
1969-2019

TOK

Serie di piccoli lampioni per illuminazione da giardino o da esterno. Disponibile in 3 diverse misure (150 mm, 400 mm, 700 mm), Tok si abbina in maniera efficace agli spazi esterni garantendo una maggiore sicurezza se si tratta di illuminare vialetti, sentieri interni o l'intero perimetro della casa. Predisposto per installazione rapida su palo Ø 60 standard, dispone di un doppio angolo d'illuminazione (360°, 180°) a supporto di ogni progetto illuminotecnico che desideri coniugare estetica a funzionalità. La versione da 150 mm può anche essere applicata a parete con l'apposita staffa di fissaggio. L'elevata resistenza agli agenti atmosferici e il diffusore in PMMA completano un'offerta unica nel suo genere.

A series of small street lights for garden or outdoor lighting available in 3 different sizes (150 mm, 400 mm, 700 mm), TOK effectively matches outdoor spaces and guarantees a greater safety when it comes to illuminate walkways, garden paths or the entire external perimeter of the house. Suitable for quick Ø60 standard pole installation, it also has a double light angle (360°, 180°) to satisfy every lighting project that wishes to combine aesthetics and functionality. The 150 mm version can also be installed on the wall with a fixing bracket. The high resistance to atmospheric agents and its PMMA diffuser complete a unique offer.

Série de bornes lumineuses pour l'éclairage du jardin ou d'extérieur. Disponible en 3 dimensions différentes (150 mm, 400 mm, 700 mm), TOK se combine efficacement avec les espaces extérieurs pour offrir plus de sécurité lorsqu'il s'agit d'éclairer les chemins, les allées de jardin ou tout le périmètre de la maison. Conçu pour une installation rapide sur un poteau Ø60 standard, il dispose d'un double angle d'éclairage pour satisfaire tout projet d'éclairage visant à allier esthétique et fonctionnalité. La version 150 mm peut également être appliquée au mur avec son support de fixation. La haute résistance aux agents atmosphériques et le diffuseur PMMA complètent un produit unique en son genre.

Serie TOK, pali luminosi all'altezza di ogni esigenza.

TOK, light poles for every need.

TOK, borne lumineuse extérieur pour tous les besoins.



Tok C H150



Tok H150



Tok C H400



Tok H400



Tok C H700



Tok H700

- Corpo in alluminio pressofuso.
- Diffusore in pmma trasparente.
- Fornito con 1m di cavo.
- Disponibile: h 150 mm, h 400 mm e h 700 mm.
- Disponibili versioni con emissione luminosa 180° o 360°.
- Predisposto per fissaggio su pali standard ø 60.

- Body made of die-cast aluminum.
- Diffuser made of pmma.
- Provided with 1m of cable.
- Available: h 150 mm, h 400 mm and h 700 mm.
- 180° or 360° light beam.
- Suitable for installation on standard post ø 60.

- Corps en aluminium moulé
- Diffuseur en pmma transparent
- Fourni avec 1m de câble d'alimentation
- Disponible: h 150 mm, h 400 mm e h 700 mm
- Angle de diffusion 180° ou 360°
- Convient à une installation sur poteaux standard de ø 60.



Tok

design: Lombardo design department

Adatto anche ad uso esterno.
Corpo e testa in alluminio; elevata resistenza all'ossidazione grazie al trattamento di cataforesi e alla verniciatura con resine poliestere stabilizzata ai raggi UV.
Completo di staffa di fissaggio in tecnopolimero. Predisposto per installazione rapida su palo Ø 60 standard.
Tirafondi e minuteria per ancoraggio del palo al terreno incluso.
Diffusore in PMMA trasparente antigraffio stabilizzato ai raggi UV.
Bulloneria in acciaio A4 con rivestimento in materiale termoplastico.
Fornito con 1 m di cavo H05RN-F pre-cablato.
LED 4000K (N), 3000K (3) o 2700K (2).
Alimentazione diretta 220 - 240V.
Nessun rischio fotobiologico, RG0 gruppo di rischio esente (EN62471).

Also suitable for outdoor use.
Aluminum body and top; highly resistant to oxidation thanks to cathoresis treatment, to zirconium-based passivation treatment and to the UV stabilized polyester resin painting.
Equipped with thermoplastic fixing bracket. Fitted for quick installation on standard Ø 60 post.
Fixing bolts and small metal parts to secure the base to the ground.
Diffuser made of transparent scratch-resistant UV stabilized PMMA.
A4 stainless steel bolts with thermoplastic coating.
Provided with 1 m of prewired cable H05RN-F.
LED 4000K (N), 3000K (3) or 2700K (2). LED.
Integrated driver 220-240V.
No risk of photobiological damage, RG0 group (EN62471).

Également adapté à l'usage à l'extérieur.
Corps et couverture en aluminium; haute résistance à l'oxydation grâce au traitement de cathorèse et passivation à base de zirconium et vernissage avec des résines polyester stabilisées aux UV.
Fourni avec étrier de fixation en technopolymère.
Prédisposé pour l'installation rapide sur poteaux standards Ø 60.
Tire-fond et visserie pour l'ancrage du poteau au sol.
Diffuseur réalisé en PMMA transparent et anti-rayures.
Visserie en acier inox type A4.
Fourni avec 1 m de câble d'alimentation H05RN-F pré-cablé.
LED 4000K (N), 3000K (3) ou 2700K (2) (blanche chaud).
Alimentation intégrée 220-240. Pas de risque photobiologique, RG0 groupe (EN62471).

Predisposto per installazione su palo da Ø60 mm standard.

Suitable for installation on standard post Ø60 mm. - Prédisposé pour l'installation sur Poteau standard Ø60 mm.

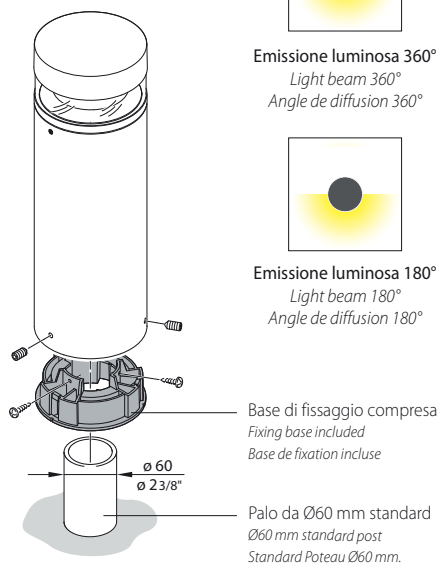
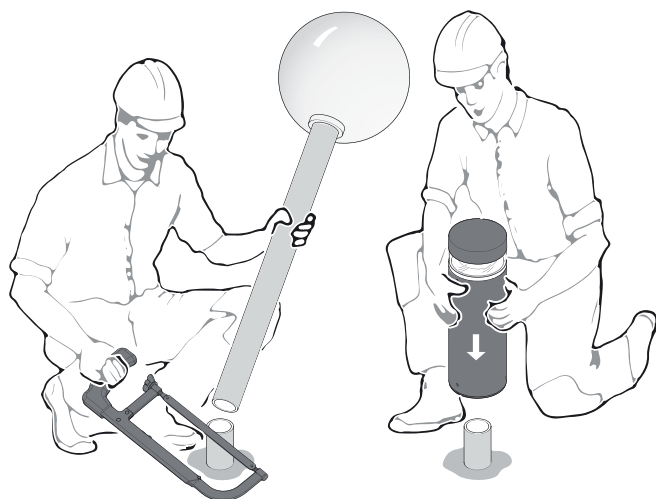

Colori disponibili

Available colours - Couleurs disponibles

■ Grigio High Tech
Grey High Tech
Gris High Tech

■ Grigio Antracite
Grey anthracite
Gris anthracite

▲ Corten





Tok C H150



Tok H150

Tok

design: Lombardo design department



Tok C H150



Specif.

Col.

€

Trasp.

(NEW)

IP 66 \diamond IK 10 20J xx9 CE

LED
930 lm 6,5W
real output lm 430

CL.I €

■ 139,00
■ 139,00
▲ 139,00

LL128000 □
LL128001 □
LL128002 □

Emissione luminosa 180°.

Light beam 180°.

Angle d'éclairage 180°.



= 1

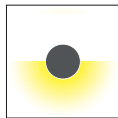
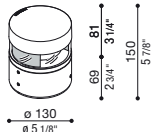

Emissione luminosa 180°
Light beam 180°
Angle de diffusion 180°

led colour

N = (4000K)
3 = (3000K, lm -5%)
2 = (2700K, lm -5%)



Tok H150



Specif.

Col.

€

PMMA

(NEW)

IP 66 \diamond IK 10 20J xx9 CE

LED
1860 lm 13W
real output lm 1010

CL.I €

■ 139,00
■ 139,00
▲ 139,00

LL128003 □
LL128004 □
LL128005 □

Emissione luminosa 360°.

Light beam 360°.

Angle d'éclairage 360°.



= 1

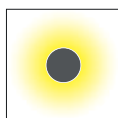
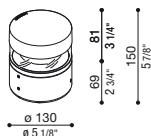

Emissione luminosa 360°
Light beam 360°
Angle de diffusion 360°

led colour

N = (4000K)
3 = (3000K, lm -5%)
2 = (2700K, lm -5%)



Tok

design: Lombardo design department



Tok C H400



Specif.

Col.

€

Trasp.

(NEW)

IP 66 IK 10 20J xx9

LED
930 lm 6,5W
real output lm 430

CL.I

■

149,00

LL128006
LL128007
LL128008

Emissione luminosa 180°.

Light beam 180°.

Angle d'éclairage 180°.

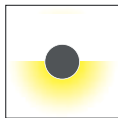
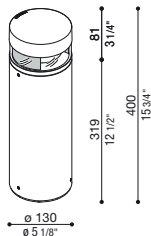

Emissione luminosa 180°
Light beam 180°
Angle de diffusion 180°

led colour

N = (4000K)

3 = (3000K, lm -5%)

2 = (2700K, lm -5%)



Tok H400



Specif.

Col.

€

Trasp.

(NEW)

IP 66 IK 10 20J xx9

LED
1860 lm 13W
real output lm 1010

CL.I

■

149,00

LL128009
LL128010
LL128011

Emissione luminosa 360°.

Light beam 360°.

Angle d'éclairage 360°.

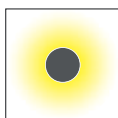
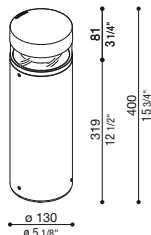

Emissione luminosa 360°
Light beam 360°
Angle de diffusion 360°

led colour

N = (4000K)

3 = (3000K, lm -5%)

2 = (2700K, lm -5%)





Tok C H700

IP 66 IK 10 20J xx9

Emissione luminosa 180°.
Light beam 180°.
Angle d'éclairage 180°.

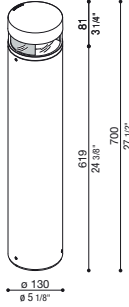

LED
930 lm 6,5W
real output lm 430



Emissione luminosa 180°
Light beam 180°
Angle de diffusion 180°

Specif.

CL.I

Col.



€

179,00
179,00
179,00

Trasp.

LL128012
LL128013
LL128014

led colour

= (4000K)
 = (3000K, lm -5%)
 = (2700K, lm -5%)

(NEW)



Tok H700

IP 66 IK 10 20J xx9

Emissione luminosa 360°.
Light beam 360°.
Angle d'éclairage 360°.

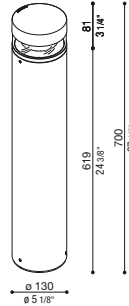

LED
1860 lm 13W
real output lm 1010

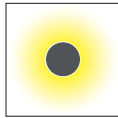

Specif.

CL.I

Col.



€

179,00
179,00
179,00

Trasp.

LL128015
LL128016
LL128017

led colour

= (4000K)
 = (3000K, lm -5%)
 = (2700K, lm -5%)

(NEW)





Tok H400

TOK

LOMBARDO



made in Italy



Lombardo S.r.l.
Via Pizzigoni, 3 - 24060 Villongo (Bergamo) Italia
Tel. +39 035 939411 Fax +39 035 939496
www.lombardo.it info@lombardo.it

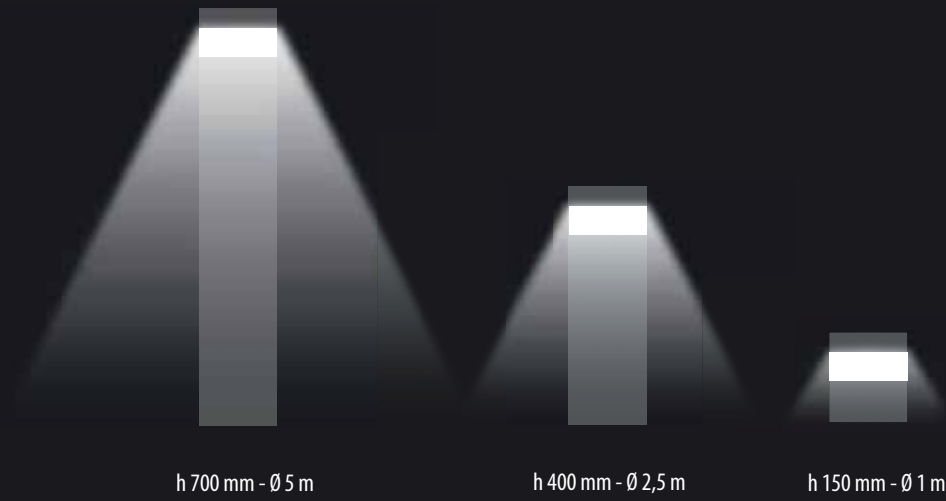

Scegliendo diverse altezze, varia l'area illuminata.
By choosing different heights, the lit area changes.
En choisissant des hauteurs différentes, la zone éclairée change.



